

EDGE™ AND EDGE GOLD™ FLOOR PANELS

NEW!
Edge Gold™ panels
with Down Pore™
self-draining
technology

- Quick and Easy Installation
- Strong and Stable
- Self-Gapping
- Warranted Against Delamination



Weyerhaeuser™ **EDGE**™
Weyerhaeuser™ **EDGE GOLD**™



GIVE YOURSELF AN EDGE ON EVERY JOB



Weyerhaeuser Edge™ oriented strand board (OSB) floor panels help builders get an edge on their competition by delivering both the value and product reliability needed for solid, stable floors. Easily recognized by their green edge seal, each Edge™ panel is uniform in size to allow easy installation, minimal waste, and reduced callbacks. Edge™ floor panels are also backed by a limited 25-year warranty against delamination.



Weyerhaeuser Edge Gold™ OSB has long been the quality builder's floor panel of choice for its outstanding performance and enhanced weather resistance. Engineered to start fat and stay fat, each panel is touch-sanded and marked with an easy-to-use fastening template for quick installation.



Edge Gold™ floor panel benefits include:

**No delamination.
No sanding.
We guarantee it.**

- Touch-sanded face for uniform thickness
- Limited 200-day no sand guarantee
- Limited 50-year structural warranty
- Stamped with fastener markings for fast nailing
- Bundles delivered face-up for easy handling on the job site
- Proprietary edge seal provides superior edge swell resistance

Why USE WEYERHAEUSER EDGE™ AND EDGE GOLD™ FLOOR PANELS?

Here's why—

- Self-gapping, tongue-and-groove edges
- Easy installation—panels go down fat and stay fat
- Consistent, reliable performance
- Limited product warranties

The products in this guide are readily available through our nationwide network of distributors and dealers. For more information on other applications or other Weyerhaeuser products, contact your Weyerhaeuser representative.



Certified Sourcing
www.sfipprogram.org
SFI-0008

NOW A GOOD THING JUST GOT BETTER:

Introducing DOWN PORE™ Self-Draining Technology

In some regions, Weyerhaeuser Edge Gold™ floor panels now include Down Pore™ technology, a patent-pending, self-draining feature that allows rainwater to drain from the floor. If your site sees a hard rain after Edge Gold™ flooring is installed, the water is channelled through the panel and off the joists below. No more sweeping off water, no more drilling holes in the floor to let it through, and less time spent waiting for flooring to dry before installing finish material.



**DOWN PORE
SELF-DRAINING
TECHNOLOGY**

Available Sizes

Edge™ and Edge Gold™ floor panels are available at Weyerhaeuser Distribution Centers in standard sizes, and in the following performance classes:

Edge™ floor panels:
1⁹/₃₂" , 2³/₃₂" , 7/8" , and 1 1/8"

Edge Gold™ floor panels:
5/8" , 2³/₃₂" , 7/8" , and 1 1/8"

*Minimum quantities may be required for some orders.
Some thicknesses and Down Pore™ technology
may not be available in your region.*

Product Specifications⁽¹⁾

Edge™ and Edge Gold™ floor panels are manufactured in accordance with Voluntary Product Standard PS2, which is recognized by:

The current and legacy codes of the International Code Council and its members (IBC, IRC, BOCA, UBC, SBCCI, and CABO).

The National Fire Protection's NFPA 5000 code.

U.S. Department of Housing and Urban Development (HUD/FHA).

⁽¹⁾ Down Pore™ drainage grooves do not affect the use of Edge Gold™ panels in fire-rated assemblies.

DESIGN PROPERTIES

In most applications, Edge™ and Edge Gold™ floor panels will be specified based on the span rating of the panel. However, in some uses, engineers will require actual design values to support application-specific engineering calculations. The **Design Values** table below provides industry-standard design values for OSB based on information in the International Building Code (IRC).

The panel design values do not need to be adjusted for panel grade or construction. However, they must be adjusted for duration of load (DOL) and creep when appropriate, and may also require other adjustments that are not shown in this guide. Refer to the current *ASD Manual for Engineered Wood Construction* for applications with elevated moisture or temperatures, applications that require preservative or fire-retardant treatment, or for panels less than 24" in width.

Geometric cross-sectional properties: To calculate the geometric cross-sectional properties for a specific Edge™ or Edge Gold™ panel, use the nominal thickness from the **Design Values** table below and assume a uniform rectangular cross section.

Creep: Under constant load, the deflection of wood-based products generally increases over time—a phenomenon known as creep. In typical applications, with relatively low dead loads, it is not necessary to consider creep in the design process. However, when the potential for creep exists—specifically, when a permanent or constant load will stress the panels to one-half or more of their design strength capacity—an adjustment to the deflection calculations should be made. For Edge™ or Edge Gold™ panels in dry-use conditions, apply the creep adjustment factor ($C_c = 0.50$) to the panel stiffness.

Design Values for Edge™ and Edge Gold™ Floor Panels (100% Load Duration)

Span rating		=	20" o.c.		24" o.c.		32" o.c.		48" o.c.	
Nominal thickness		=	19/32", 5/8"		23/32"		7/8"		1 1/8"	
Strength axis ⁽¹⁾		=	Primary	Secondary	Primary	Secondary	Primary	Secondary	Primary	Secondary
Bending	Moment capacity (lb-in./ft of width)	$F_b S$	575	250	770	385	1,050	685	1,900	1,200
	Stiffness (lb-in. ² /ft of width)	EI	210,000	40,500	300,000	80,500	650,000	235,000	1,150,000	495,000
Shear	Shear capacity in-the-plane (lb/ft of width)	$F_v(Ib/Q)$	205	205	250	250	300	300	385	385
	Rigidity through-the-thickness (lb/in. of panel depth)	$G_v t_v$	87,000	87,000	93,000	93,000	110,000	110,000	155,000	155,000
	Shear capacity through-the-thickness (lb/in. of shear-resisting panel length)	$F_v t_v$	195	195	215	215	230	230	305	305
Axial	Axial tension capacity (lb/ft of width)	$F_t A$	2,900	2,100	3,350	2,550	4,000	3,250	5,600	4,750
	Axial compression capacity (lb/ft of width)	$F_c A$	4,200	4,000	5,000	4,300	6,300	6,200	8,100	6,750
	Stiffness (lb/ft of width x10 ⁶)	EA	5.00	2.90	5.85	3.30	7.50	4.20	8.20	4.60

(1) The primary strength axis is the long direction of the panel unless otherwise noted.

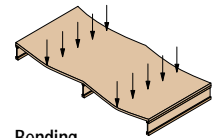

Bending

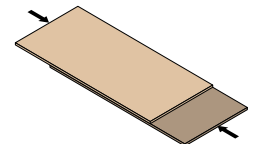

Shear-in-the-Plane (Rolling or Interlaminar Shear)

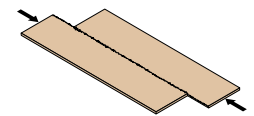

Shear-through-the-Thickness

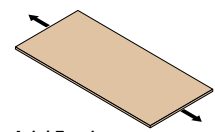

Axial Tension

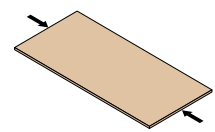

Axial Compression

General Notes

Table is based on information from the International Building Code (IRC).

Value must be adjusted for duration of load, creep, elevated moisture or temperature, applications that require preservative or fire-retardant treatment, or for panels less than 24" in width when appropriate. Refer to the current *Manual for Engineered Wood Construction*.

Values do not need to be adjusted for panel grade or construction.

Nail or Screw Design Values

Design values for nails or screws used with Edge™ and Edge Gold™ panels can be computed by engineers using the same 2005 NDS® procedures used for other structural wood products.

For withdrawal, use equivalent Specific Gravity (SG) as follows: smooth- or screw-shank nails = 0.40, ring-shank nails = 0.70, wood screws = 0.45. Design values for nail or screw withdrawal resistance are shown in 2005 NDS® Table 11.2B (screws) and Table 11.2C (nails).

For lateral resistance, use equivalent Specific Gravity (SG) = 0.50. Design values for nail or screw lateral resistance are found in 2005 NDS® Tables 11L (screws) and 11N (nails).

APPLICATION ADJUSTMENT FACTORS

Span Adjustments

	2-Span to 1-Span	3-Span to 1-Span
Deflection	0.42	0.53
Moment	1.00	0.80
Shear	1.25	1.20

When adjusting uniform loads based on strength from the **Allowable Uniform Loads** table on page 4, use the span adjustment factor for moment.

When adjusting uniform loads calculated from the equations on page 5, use the appropriate corresponding factor.

Duration of Load (C_D) (Applies to strength capacities)

Permanent load (over 10 years)	0.90
Occupancy live load	1.00
2 months, as for snow	1.15
7 days	1.25
Wind or earthquake	1.60
Impact	2.00

Creep Adjustment Factor (C_c) (For permanent loads)

Moisture Condition	OSB
Dry	0.50

When a permanent or constant load will stress a panel to ½ or more of its design strength capacity, adjust the deflection calculation by applying the creep adjustment factor (C_c) to the panel stiffness (EI) found above.

SECTION PROPERTIES AND LOAD/SPAN TABLE

Panel Section Properties⁽¹⁾

		19/32"	5/8"	23/32"	3/4"	7/8"	1"	1 1/8"
Approximate weight (psf)	=	2.0	2.1	2.4	2.5	2.9	3.3	3.6
Nominal thickness (in.)	t =	0.594	0.625	0.719	0.750	0.875	1.000	1.125
Area (in. ² /ft)	A =	7.125	7.500	8.625	9.000	10.500	12.000	13.500
Moment of inertia (in. ⁴ /ft)	I =	.209	.244	.371	.422	.670	1.000	1.424
Section modulus (in. ³ /ft)	S =	.705	.781	1.033	1.125	1.531	2.000	2.531
Statical moment (in. ³ /ft)	Q =	.529	.586	.775	.844	1.148	1.500	1.898
Shear constant (in. ² /ft)	Ib/Q =	4.750	5.000	5.750	6.000	7.000	8.000	9.000

Edge™ and Edge Gold™ panels are intended for dry-use applications

(1) Properties based on rectangular cross section of 1' width.

Geometric properties are calculated on a per-foot-of-panel width basis. These properties may be used to find design stresses when required. To do so, divide the design capacity by the applicable section property. You may also calculate the geometric cross-sectional properties for a specific Edge™ or Edge Gold™ panel by using the nominal thickness from the table above and assuming a uniform rectangular cross section.

Allowable Uniform Loads (PSF) for Edge™ and Edge Gold™ Floor Panels (100% Load Duration)

Span Rating	Nominal Thickness	Load Calculation Based on ⁽¹⁾⁽²⁾	Span												
			Normal Orientation, Strength Axis Perpendicular to Supports										Strength Axis Parallel to Supports ⁽³⁾		
			12"	16"	19.2"	24"	30"	32"	36"	40"	48"	60"	12"	16"	24"
20" o.c.	19/32", 5/8"	Deflection	914	344	188	91	45	36	32	23	15		175	66	22
		Strength	390	270	188	120	77	68	43	35	24		210	118	42
24" o.c.	23/32"	Deflection	1,305	491	269	130	64	52	46	33	21	10	351	132	45
		Strength	476	345	250	160	102	90	57	46	32	20	323	181	65
32" o.c.	7/8"	Deflection	2,828	1,064	582	282	138	113	99	71	46	23	1,011	381	128
		Strength	571	414	339	218	139	122	77	63	44	28	570	321	114
48" o.c.	1 1/8"	Deflection	5,003	1,882	1,030	499	244	199	175	126	82	40	2,158	812	274
		Strength	733	531	435	342	256	225	142	115	80	51	733	531	204

(1) Deflection calculation based on L/360 deflection limit. The allowable load for other deflection limits can be computed as follows:

- for L/240 limit, multiply by 1.5
- for L/180 limit, multiply by 2.0
- for L/480 limit, divide by 1.5

(2) Strength calculation based on the minimum of bending or shear.

(3) Values may be increased for Structural 1 sheathing with strength axis parallel to supports. For values based on deflection, multiply by 1.60. For values based on strength, use the equations provided and Structural 1 sheathing design values.

General Notes

Table is based on:

- Uniform loads. See PS2 and local building codes for concentrated load and other requirements.
- Untreated Exposure 1-rated panel in dry conditions.
- Typical sheathing applications such as floors, walls, and roofs.
- 2x supports for span configurations less than 48" on-center. Support width effects have been considered.
- 4x supports for span configurations equal to or greater than 48" on-center. Support width effects have been considered for shear and deflection calculations. Moment calculations do not consider support width effects.

For **Strength Axis Perpendicular to Supports:**

- 3-span condition is assumed for spans of 32" or less.
- 2-span condition is assumed for spans greater than 32".
- 1-span condition requires the use of the span adjustment factor on page 3.

For **Strength Axis Parallel to Supports:**

- 3-span condition is assumed for spans of 16" or less.
- 2-span condition is assumed for spans of 24".
- 1-span condition requires the use of the span adjustment factor on page 3.

A Note About Floor Performance

Floor panels are an important component in creating a floor that feels good to customers. The span rating shown on a panel represents a structurally acceptable floor performance level. Floor performance can be enhanced to meet higher customer expectations in several ways:

Consider using thicker panels.

Glue and nail flooring for improved connections to help resist vibrations, minimize nail pops, and transfer loads more evenly. Weyerhaeuser recommends using solvent-based subfloor adhesives that meet ASTM D3498 (AFG-01) performance standards. When latex subfloor adhesive is required, careful selection is necessary due to a wide range of performance between brands.

Use stiffer joists or a narrower joist spacing.

Choosing the optimal combination of these parameters can be difficult. To predict floor performance and evaluate the relationship between the cost and the "feel" of a floor, use Trus Joist® TJ-Pro™ Ratings.

CALCULATING UNIFORM LOADS

One-Span Equations

Uniform load equations based on:

$$\text{Moment Capacity } W_M = \frac{96F_b S}{L_M^2}$$

$$\text{Shear Capacity } W_V = \frac{24F_s(Ib/Q)}{L_V}$$

$$\text{Deflection } W = \frac{L_M 921.6 EI}{L^4 R}$$

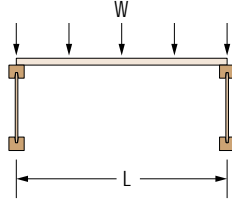

Two-Span Equations

Uniform load equations based on:

$$\text{Moment Capacity } W_M = \frac{96F_b S}{L_M^2}$$

$$\text{Shear Capacity } W_V = \frac{19.2F_s(Ib/Q)}{L_V}$$

$$\text{Deflection } W = \frac{L_M 2220 EI}{L^4 R}$$

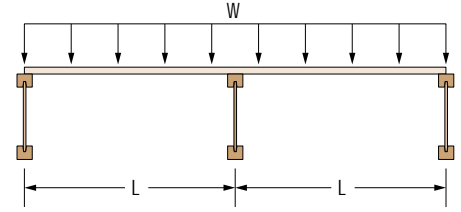

Three-Span Equations

Uniform load equations based on:

$$\text{Moment Capacity } W_M = \frac{120F_b S}{L_M^2}$$

$$\text{Shear Capacity } W_V = \frac{20F_s(Ib/Q)}{L_V}$$

$$\text{Deflection } W = \frac{L_M 1743 EI}{L^4 R}$$

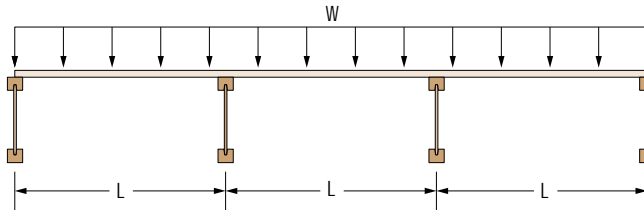

The equations above are based on one-way "beam" action. They are provided to help develop allowable uniform loads based on moment, shear, and deflection as applied to one-, two-, and three-span conditions. Loads derived from the equations provided are assumed to be applied over full-size panels in normal sheathing applications. The following definitions apply:

- deflection (in.)
- EI design bending stiffness capacity (lb-in.²/ft)
- F_bS design moment capacity (lb-in./ft)
- F_s(Ib/Q) ... design shear capacity (lb/ft)
- L span (in.)
- L_M span, center-to-center of supports, used for moment calculation (in.)
- L_V clear span, used for shear calculation (in.)
- L clear span plus SW, used for deflection calculations (in.)
- R denominator of chosen deflection limit. Example: deflection limit = L/360 then R = 360

- SW support width factor:
 - 0.25 for 2x nominal lumber
 - 0.625 for 4x nominal lumber
 - For additional information refer to the current *Manual for Engineered Wood Construction*
- W uniform load (psf)
- W_M uniform load based on moment capacity (psf)
- W_V uniform load based on shear capacity (psf)
- W uniform load based on deflection (psf)

Example Problem

Find the maximum allowable uniform load (psf) for 24" o.c. span-rated flooring over 16" on-center joists.

Assumptions

- 24" o.c. span-rated flooring
 - Full 4'x8' panel
 - Strength axis perpendicular to joists
 - Use 3-span equations

Joist Spacing = 16" o.c.

Joist Width = 1.5"

Deflection = L/360

Locate panel design values for moment, shear, and stiffness on page 3.

Moment capacity (primary) = F_bS = 770 lb-in./ft of width

Shear capacity (in-the-plane) = F_s(Ib/Q) = 250 lb/ft of width

Stiffness = EI = 300,000 lb-in.²/ft of width

1 Calculate Allowable Uniform Load Based on Moment Capacity

$$W_M = \frac{120F_b S}{L_M^2}$$

Calculate appropriate span for moment (center-to-center), L_M = 16"

Using: F_bS = 770 lb-in./ft and L_M = 16"

$$W_M = 120 \times 770 / 16^2$$

$$W_M = 361 \text{ psf}$$

2 Calculate Allowable Uniform Load Based on Shear Capacity

$$W_V = \frac{20F_s(Ib/Q)}{L_V}$$

Calculate appropriate span for shear (clear span), L_V = 16" - 1.5" = 14.5"

Using: F_s(Ib/Q) = 250 lb and L_V = 14.5"

$$W_V = 20 \times 250 / 14.5$$

$$W_V = 345 \text{ psf}$$

3 Calculate Allowable Uniform Load Based on Deflection

$$W = \frac{L_M 1743 EI}{L^4 R}$$

$$SW = 0.25 \text{ (from above)}$$

Calculate appropriate span for deflection (clear span + SW),

$$L = 14.5" + 0.25" = 14.75"$$

Using: L_M = 16", R = 360, and

$$EI = 300,000 \text{ lb-in.}^2/\text{ft}$$

$$W = (16 \times 1743 \times 300,000) / (14.75^4 \times 360)$$

$$W = 491 \text{ psf}$$

4 Compare Calculated Allowable Uniform Loads

Calculated allowable uniform loads based on strength:

$$W_M = 361 \text{ psf}$$

$$W_V = 345 \text{ psf}$$

$$W_V \text{ controls}$$

Calculated allowable uniform load based on deflection:

$$W = 491 \text{ psf}$$

PRODUCT STORAGE AND HANDLING

Like any wood product, wood-based panels are at risk of fungal decay or rot if exposed to repeated wetting or high-moisture environments. Panels that are exposed to such conditions may deteriorate, lose strength, or support mold growth, so protection from these conditions must be provided.

Use a platform made from cull panels and scrap lumber supported by stickers that extend across the width of the stack, and keep panels at least 4" from the ground. Put one sticker in the center of the load and the others approximately 12" from each end. When covering the panels, drape plastic over the ends of the stack and secure it. Then drape plastic over the top and sides of the stack; stake it to the ground, pulling the ends away from the product to allow air circulation along the sides of the stack.

Handle Edge™ and Edge Gold™ panels in a flat orientation. Protect the edges and ends from damage, keep the load level, and lift the stack from the center.

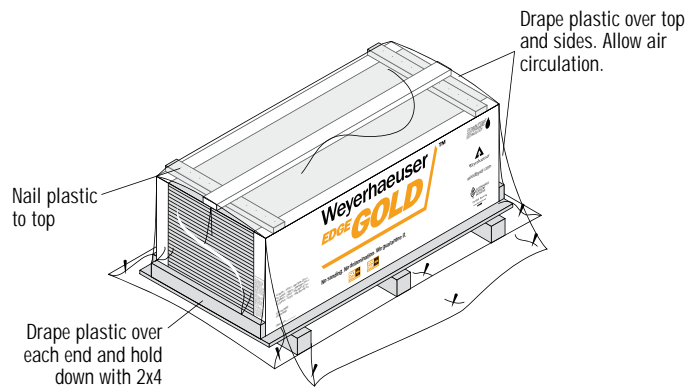

Exposure 1 Bond Classification

Edge™ and Edge Gold™ panels are manufactured to an Exposure 1 bond classification. Exposure 1 panels are suitable for uses where they are not permanently exposed to the weather; they are intended to resist the effects of moisture on structural performance due to construction delays or other conditions of similar severity.

Edge™ and Edge Gold™ panels are intended for dry-use applications

WARNING: Drilling, sawing, sanding or machining wood products generates wood dust, a substance known to the State of California to cause cancer.
For more information on Proposition 65, visit wy.com/inform.

PRODUCT WARRANTIES



Visit woodbywy.com/warranty for copies of these and other Weyerhaeuser product warranties.

Contact your local representative or dealer at

CONTACT US

1.888.453.8358 • woodbywy.com

