

Beach House Shake[®]
The **Authentic** Composite Shingle



Tando Stone[®]
#1 Brand of Composite Stone



Product
Catalog

Tando[®]
COMPOSITES 

tandocomposites.com | beachhousesshake.com

The perfect composites for amazing exteriors

Tando, a brand of Derby Building Products, is the leader in composite cladding with Beach House Shake[®], the authentic composite shingle, and TandoStone[®], the #1 brand of composite stone.

Backed by more than five decades of product innovation, Tando Composites produces high performance products professionals prefer and consumers demand.

TABLE OF CONTENTS

About Tando Composites	3
Beach House Shake	4
Product Information	6
Awards	9
Atlantica	10
Pacifica	12
Sandcastle	14
Hatteras	16
Seeing is Believing	18
Installation / Specifications	20
Tando Stone	22
Product Information	24
Stacked Stone	30
Creek Ledgestone	32
Architectural Sill	36
Product Specifications	38



**Beauty that never
grows old.**

Imagine if natural cedar shingles could stay looking “perfect” - from the day they were installed for the life of a home. Now they can with Beach House Shake, the authentic composite shingle.

Beach House Shake’s innovative composite technology delivers a new level of authenticity along with architectural precision. Every individual shingle is unique with the subtle nuances of natural cedar shingles.

Sandcastle
Bay Shore, NY

**Everything you want from
natural cedar shingles.
Nothing you don't.**

Newly installed natural cedar shingles are beautiful until exposure to the elements causes uneven discoloration, streaking, splitting, and cupping. And trying to preserve their natural look is a never-ending battle that can't be won.

With the proven performance and durability of a composite, Beach House Shake is engineered to last. And its unique KAPGUARD[®] with Kynar[®] coating provides color protection for 20+ years.

**NATURAL CEDAR
SHINGLES**



BEACH HOUSE SHAKE

**Sandcastle
Ontario, Canada**



**Pacifica
Bessemer, AL**

Why Beach House Shake?

Authenticity of natural cedar shingles. Performance of a composite.

Down to the last detail, Beach House Shake has the natural color variations, genuine saw cuts, and detailed grain patterns of natural cedar shingles. Its architecturally precise 5" re-squared and rebuted lines deliver individual shingles as unique as they are beautiful.

Beach House Shake's composite technology provides proven performance. Unlike natural cedar shingles, Beach House Shake will not discolor, crack, cup, or be damaged by insects.



Atlantica
Fire Island, NY



Pacifico
Captree Island, NY



Hatteras
Jamestown, RI



Named the
2022 MOST VALUABLE PRODUCT
in the Exteriors
Category by
PRODUCTS

Named
HOT PRODUCT FROM IBS 2023
and
EDITOR'S PRODUCT PICK
by **LBM JOURNAL**



Award winning recognition. Code certified for peace of mind.

- Approved by Miami-Dade County for use in High Velocity Hurricane Zones (HVHZ) and severe weather conditions 
- Protected by KAPGUARD[®] by Kynar[®] for 20+ years of color protection
- Building code approved by ICC and CCMC
- Backed by a 50-Year Performance Plus Limited Warranty and an industry leading, 20-Year Beautiful Freedom Limited Warranty.
- Complete product information, technical documents, and code reports on www.BeachHouseShake.com.

Even the experts know a good thing when they see it.

“At Mid Cape, we have served multiple generations on the Cape and surrounding communities since 1895 and we’re known for supplying natural cedar shingles - part of the beauty and charm of this region. For the past several years, the demand of cedar shingles has outpaced the available supply. We’ve been researching alternative offerings to complement our natural cedar shingle business. It was paramount that the new product protects both the tradition and beauty of the Cape. We were looking for a product with the undeniable appearance of bleached cedar shingles. Additionally, unmatched performance and ease of installation were “must haves”. After years of evaluating many alternatives, we’re excited to select Beach House Shake as the brand that has the appearance, performance, and application ease for our customers.”

- Mid-Cape Home Centers Management, Massachusetts



Atlantica

ATLANTICA

Capture the silvery gray tones reminiscent of bleached cedar shingles typically seen in northern coastal regions. Atlantica is the perfect way to replicate the charm of a seaside beach house.



Atlantica
Narragansett, RI



Pacifica
Trenton, ME

Beach House Shake captures a specific “moment in time” of natural cedar that homeowners wish they could have - and keep.

“Michele and I fell in love with it! Beach House Shake in Pacifica was the answer to our prayers. We created a color décor palette around our house to match it. We’re amazed at how many people are fooled by Beach House Shake. They think it’s western red cedar. A friend who operates a cedar mill created a 12 ft. pergola for us and even he thought it was authentic cedar, and he works with cedar every day!”

Philip from Bessemer, AL

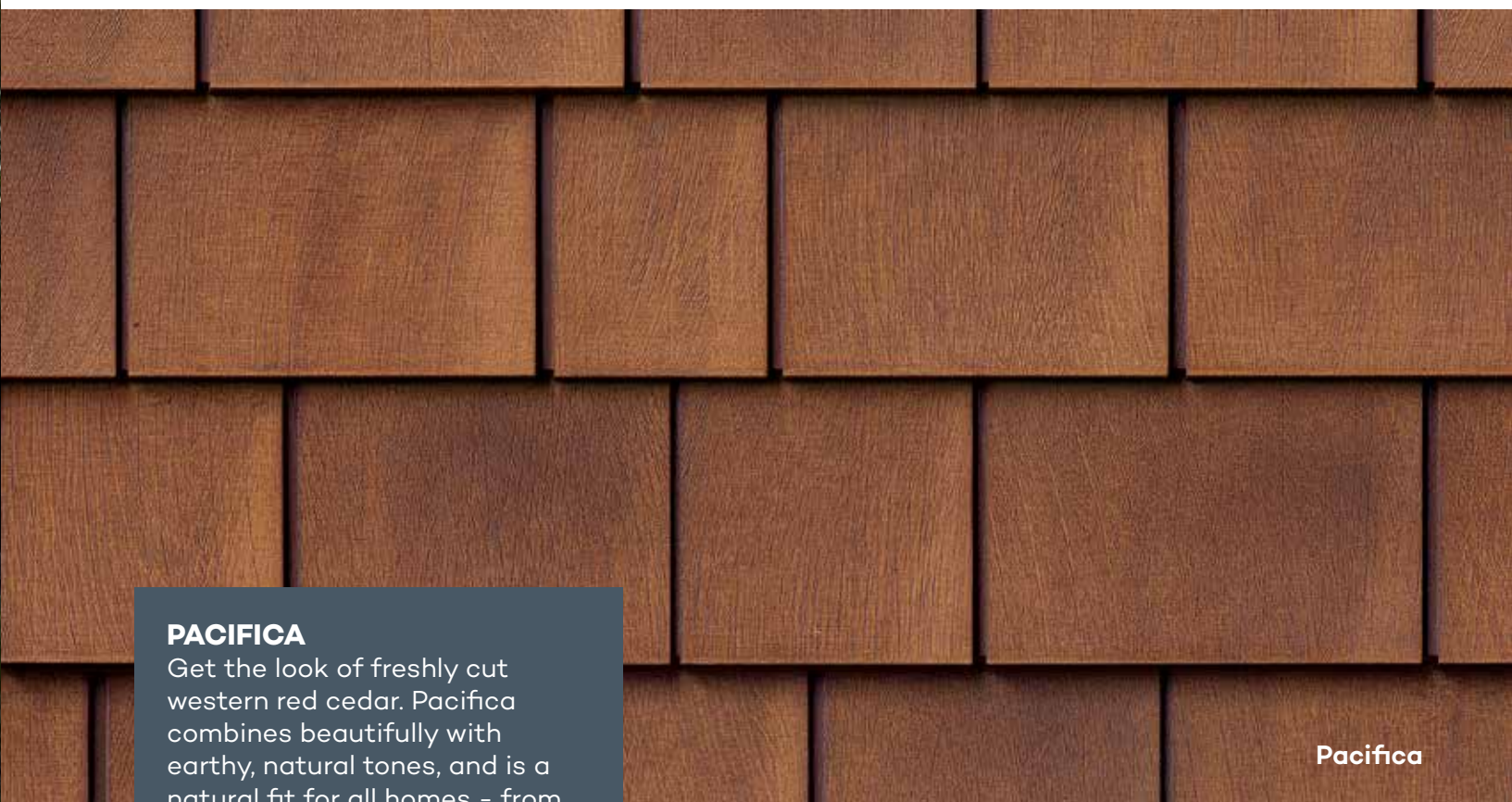

PACIFICA

Get the look of freshly cut western red cedar. Pacifica combines beautifully with earthy, natural tones, and is a natural fit for all homes - from the coast, to the lakefront, and the mountains. Its deep rich blend makes it a bold statement that stays looking like the day it was installed.

Pacifica

Fooling the neighbors has never been so easy and so worth it.

"We think Beach House Shake is an incredible product. We really wanted to stay true to the architectural style of our region. Natural cedar shingles look great to start, but fade in such a short period of time and I just didn't like the effect that time had on them. Beach House Shake will stay looking new so I can relax and not worry. When people come to see our home, they tell us they love our eastern white cedar shingles."

Michael from Bay Shore, NY



Sandcastle

SANDCASTLE

Achieve the classic appeal of brand new eastern white cedar shingles. Sandcastle looks stunning on full walls and entire homes, and can also be used to brighten and accentuate architectural details such as gable ends. Its simple beauty will last for the life of the home.

Sandcastle
Bay Shore, NY

**Mother Nature can't tell the difference either.
And she can't do anything about it.**

"Our house is right on the water's edge on Little Alum Lake, and we have a boat, so we enjoy the outdoors. Most people in New England use bleached cedar shingles. We wanted something different and love the darker shades of cedar shingles that are seen in the southern coastal areas. We chose Beach House Shake's Hatteras because of its authentic cedar shingle look. It was really the perfect solution for us."

Anthony from Brimfield, MA



Hatteras
Narragansett, RI

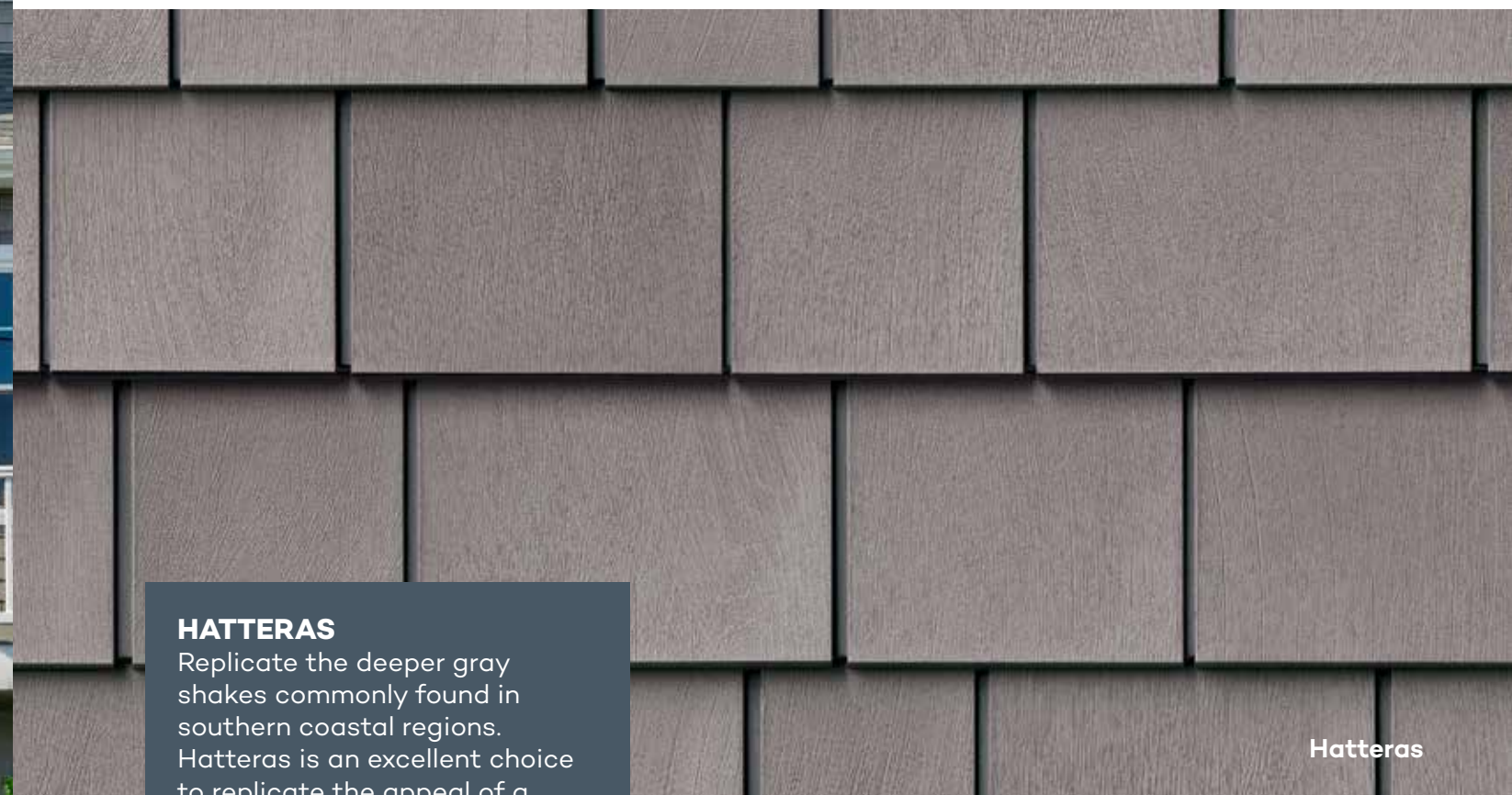

HATTERAS

Replicate the deeper gray shakes commonly found in southern coastal regions. Hatteras is an excellent choice to replicate the appeal of a classic seaside retreat.

Hatteras



If you can visualize it, you can build it. No, really, you can.

Have you ever wished you could see how a project might look using a new product? Maybe you want to see all the different options or maybe you just want to see if your project would look as good as it does in your mind's eye.

Scan here to access the Beach House Shake visualizer and bring your visions to life. Or contact a Tando Sales Rep for assistance.



You can also order accurate measurements, 3D models, and expertly prepared interactive visualizations of a home just by entering an address.



REAL LIFE EXAMPLE: THE POWER OF A VISION

A homeowner from Southampton, New York was not happy with the look of his home. Like all exposed natural cedar, it had discolored quickly, unevenly, and was unsightly. He submitted this “Before” photo and asked for help with a visualization using Beach House Shake. The local Sales Rep assisted the homeowner and provided the below “Proposed” image. The homeowner was thrilled with the look and proceeded with the transformation. In late 2022, the homeowner sent us the below “After” photo to show how his dream had finally come to life. With the Beach House Shake Visualizer, seeing is believing!



BEFORE
Photo submitted by customer



PROPOSED
Using the Beach House Shake Online Visualizer



AFTER
With Beach House Shake Pacifica Installed

More than just a pretty face. Get on and off the next jobsite fast.

With Beach House Shake, you can forget the time consuming and tedious installation of traditional cedar shingles. No more string lines. No more measuring pole. And no more shingle sorting.

Beach House Shake was engineered for quick and easy installation - installing more than 5x faster than natural cedar shingles. For example, installing 5 sq. feet of cedar shingles requires at least 42 fasteners. The same coverage of Beach House Shake is installed using only 7 fasteners.

Beach House Shake was designed to be installed with most common nail guns to further speed installation.



















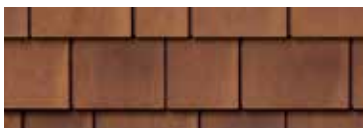

Atlantica



Scan here for Beach House Shake Technical Resources and Installation Guides.

HOW TO BUY BEACH HOUSE SHAKE:

1. BEACH HOUSE SHAKE PANELS	2. BEACH HOUSE SHAKE CORNERS	3. STARTER STRIP (Required)	4. ACCESSORY OPTIONS - 3/4" J-Channel	
Styles	Matching Corner	Universal Starter Strip (Required)	3/4" J-Channel Color Match	Other
 Atlantica			 Atlantica / Light Gray	 White  Char/Black
 Hatteras			 Hatteras	
 Pacifica			 Pacifica	
 Sandcastle			 Sandcastle	

BEACH HOUSE SHAKE PRODUCT SPECIFICATIONS:

Beach House Shake Panel

Finished Exposure: 42.63" w X 15" h
Shingle Exposure: 5"
Squares per box: 1/2
Panels per box: 11
Boxes / Squares per pallet: 28/14



Beach House Shake Corner

Dimensions: 3.75" w X 3.75" d X 15" h
Pieces per box: 5
Linear ft. per box: 6.25



Universal Starter Strip (Required)

Dimensions: 10 ft.
Pieces/Box: 25
Linear ft./box: 250



3/4" J-Channel

Length: 12 ft. 6 in.
Pieces/Box: 40
Linear ft./box: 500



On a river somewhere



**First there was stone.
Then stone veneer.
Now there's TandoStone, the
#1 brand of composite stone.**

Preferred by siding installers, TandoStone, the leading brand of composite stone, has turned the stone siding market upside down.

Without compromising on beauty or performance, TandoStone installs in a fraction of the time of stone or stone veneer with standard siding tools. And once an installer switches to TandoStone, they never go back.

TandoStone allows builders, designers, specifiers, and installers to turn ordinary walls into mixed material exteriors in order to meet today's popular trends.

Install faster.

Save time and money.

Achieve design excellence.

Capture more share of the "wall".

It's no wonder that installers ask ...

"Where has this product been?"

STACKED STONE
Lewiston Crest

Strong looks are just the beginning.

Easy to install - no need for specialized trades or sub-contractors on the job. TandoStone is lightweight and is installed like traditional siding.

Clean on the jobsite - TandoStone composite stone never requires mortar or adhesive for installation. Contains no harmful silica, creates no dust, and can be cut with common saw blades.

Proprietary technology - unique composite stone is impervious to moisture. Can be installed at ground level or roof line. And, unlike stone veneer, does not require a secondary rainscreen and can be installed in any weather - hot, cold, wet, or dry.

Engineered to perform - TandoStone is developed by Tando, the industry leader in composite technology, and backed by five decades of product innovation. Tando products are trusted by top remodelers, builders, specifiers, and multi-family developers.

Guaranteed to last - Backed by a 50-Year Performance Plus Limited Warranty and an industry leading, 20-Year Rock Solid Limited Warranty.



CREEK LEDGESTONE
 Bucks County Gray



STACKED STONE
 Sedona Bluff



CREEK LEDGESTONE
 Bucks County Gray

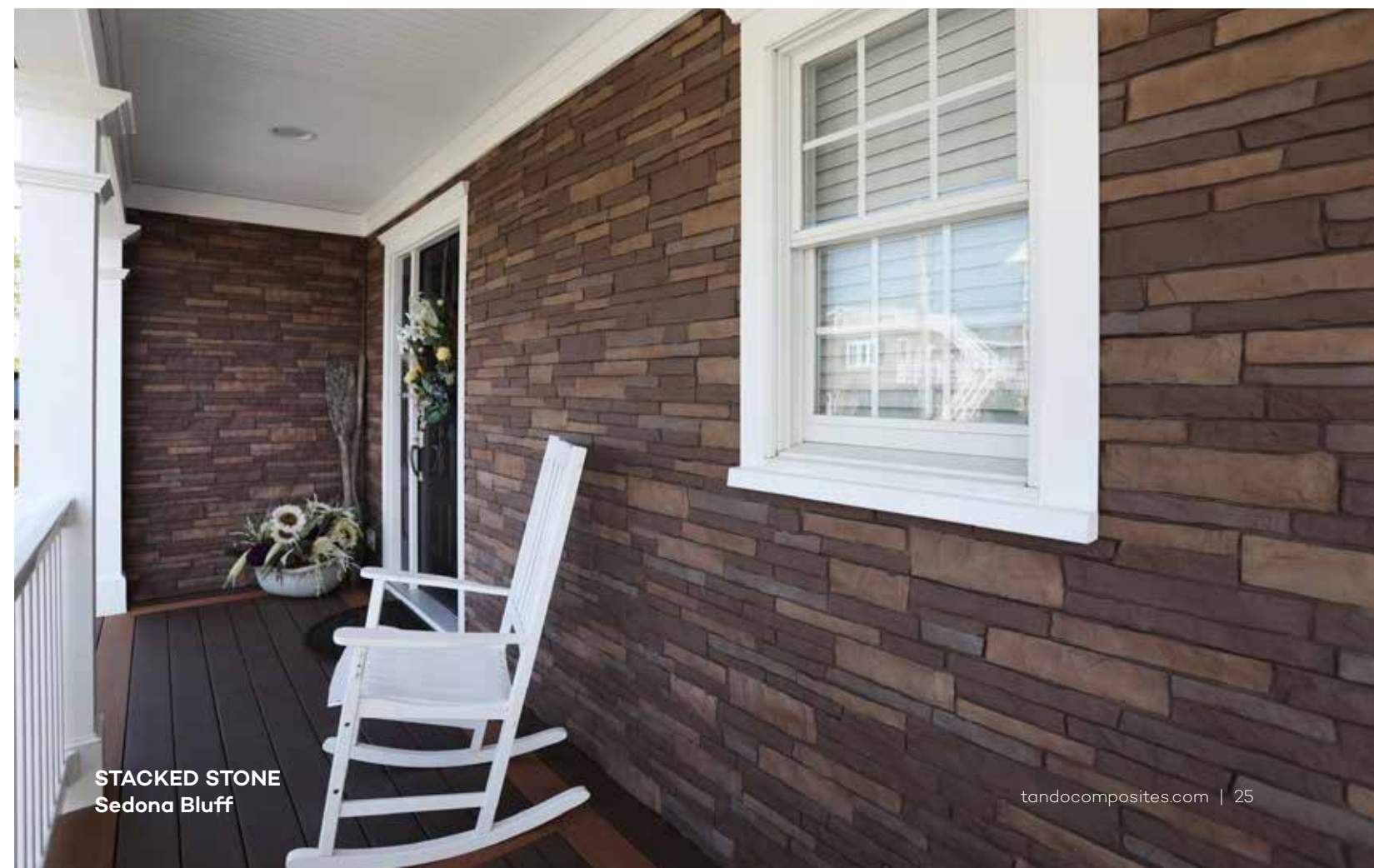

STACKED STONE
 Sedona Bluff

A perfect fit for any application

Today's exterior contemporary design trends are all about mixed materials. TandoStone is a perfect fit to add masonry elements to all projects.

With its ease of installation, cost benefits, and proven performance, TandoStone is a great solution for single-family, multi-family, and commercial projects - whether they are new construction or R&R.



DID YOU KNOW?

According to Remodeling's 2022 Cost vs Value Report, Stone is the #2 Remodeling Product to increase ROI - over 91%!



BEFORE



AFTER

Single Family



Creek Ledge stone - Nordic Mist



Stacked Stone - Sedona Bluff



Creek Ledge stone - Bucks County Gray

Multi- Family



Stacked Stone - Santa Fe



Creek Ledge stone - Bucks County Gray



Stacked Stone - Glacier Bay

Commercial



Stacked Stone - Sedona Bluff



Stacked Stone - Lewiston Crest



Creek Ledge stone - Bucks County Gray



**Available in two styles,
 the choice is yours.**

TandoStone is available in
 Stacked Stone and Creek
 Ledgerstone.

All TandoStone products feature
 Tando TruGrit™, a unique finish
 that provides the rough, gritty
 feel of natural stone.



Stacked Stone



Creek Ledgerstone

*A survey of builders conducted
 by the NAHB/Wells Fargo
 Housing Market Index found
 that bricklayers and masons
 were among the top five
 specialized trades where
 serious shortages or some
 shortage of labor is reported.
 The surveyed builders
 reported shortages 73% of the
 time while trying to source
 bricklayers and masons.*

**No masons? No problem!
 TandoStone is installed by
 siding installers.**



STACKED STONE
 Chestnut Hills



CREEK LEDGESTONE
 Nordic Mist

**Stacked Stone -
 Lining up for a beautiful finish**

TandoStone Stacked Stone features stones of low heights and random lengths. A strong linear pattern with minimal grout lines, Stacked Stone is a contemporary, sharp edged look that complements any exterior finish.



Santa Fe



Glacier Bay

Stacked Stone Panel and Corner Options:



Glacier Bay



Lewiston Crest



Santa Fe



Sedona Bluff



Chestnut Hills



**Creek LedgeStone -
 Rugged, natural beauty**

TandoStone's Creek LedgeStone has varied sized stones set in a strong horizontal ledge. With a rough, dimensional surface and generous grout lines, Creek LedgeStone creates appealing natural shadows.



Creek LedgeStone Panel and Corner Color Options:



Stacked Stone

Creek Ledgestone



Glacier Bay



Santa Fe



Bucks County Gray



Appalachian Ash



Chestnut Hills



Lewiston Crest



Arizona Sandstone



Rocky Mountain Clay

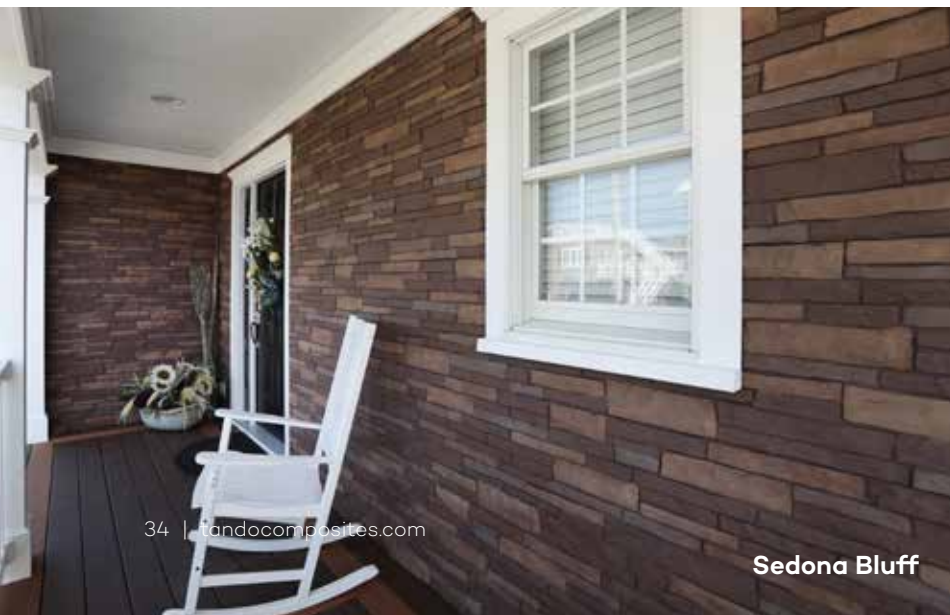

Sedona Bluff

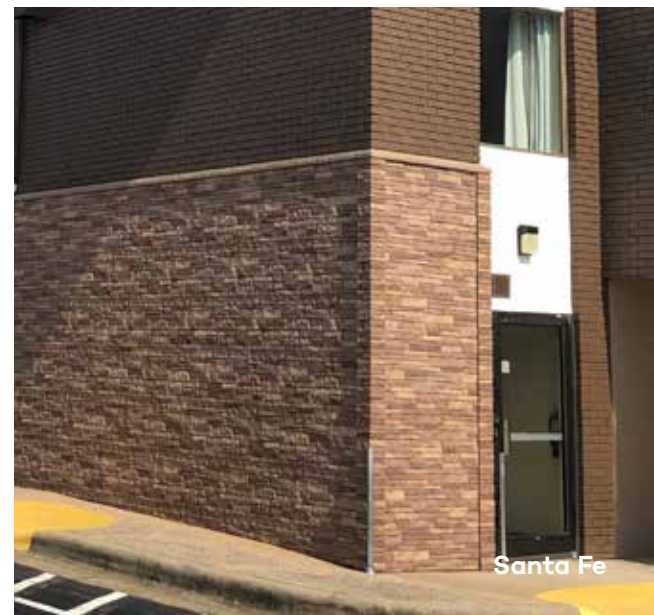

Santa Fe



Rocky Mountain Clay



Bucks County Gray

The Transition is Easy with Tando Architectural Sill

Tando Architectural Sill is a deep profile that is architecturally accurate and complements all TandoStone styles.

Designed with a slope forward to direct water away from a structure, Tando's Architectural Sill offers superior moisture management while delivering beauty and functionality.

As a complement to the Architectural Sill, Tando has also developed an Architectural Sill Corner that can be used as a corner or can be easily cut on the left side or right side to act as an end cap to terminate a run.

The Architectural Sill offers two other game-changing innovations: an integrated nailing flange that can be re-purposed as a starter strip to easily install the Sill under a window and breakaway spacers on the back of the profile that can be used as "shims" to transition products that require additional clearance.

Tando's Architectural Sill works with Stacked Stone and Creek Ledgestone.

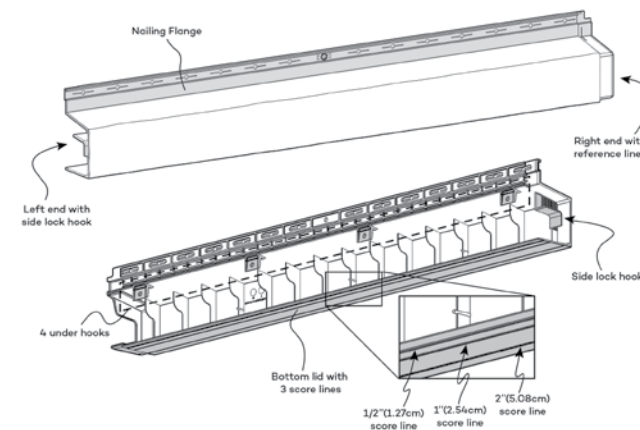
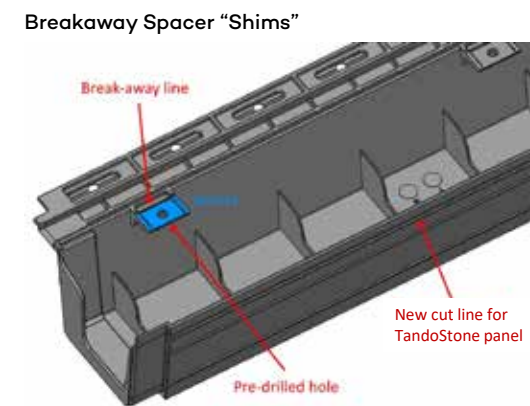
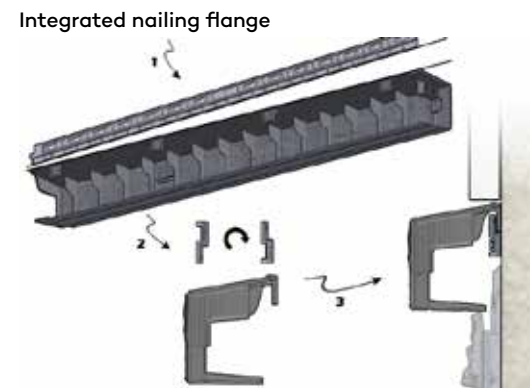

Scan here to watch a short installation video.



Architectural Sill Corners can be used as a corner or to terminate the end of a run.



Tando Architectural Sill is the perfect transition between shake and stone

Three popular shades. A beautiful complement for TandoStone.



Architectural Sill Corner available in all colors

Creek Ledgestone - Panel

Finished Exposure: 40" w X 18.13" h
Exposure: 18.13"
Squares per box: 1/2
Panels per box: 10
Boxes per pallet: 16
Squares per pallet: 8



* Universal Starter Strip, sold separately, is required

Creek Ledgestone - Corner

Finished Exposure: 7.25" w X 7.38" d X 18.13" h
Pieces per box: 5
Linear ft. per box: 7.5



* Universal Starter Clips are included in each box

Stacked Stone - Panel

Finished Exposure: 39.68" w X 18.25" h
Exposure: 18.25"
Squares per box: 1/2
Panels per box: 10
Boxes per pallet: 16
Squares per pallet: 8



* Universal Starter Strip, sold separately, is required

Stacked Stone - Corner

Finished Exposure: 6.5" w X 6.38" d X 18.25" h
Pieces per box: 6
Linear ft. per box: 9.2



* Universal Starter Clips are included in each box

TandoStone Accessories

Architectural Sill Corner (Optional)

Finished Exposed Width: 5.0" (12.7 cm)
Finished Exposed Height: 2.63" (6.67 cm)
Depth: 2.5" (6.35 cm)
Arch. Sill Corners per box: 4



Universal Starter Strip (Required)

Dimensions 10 ft. Pieces/Box 25 Linear ft./box 250



Architectural Sill (Optional)

Finished Exposed Width: 30.13" (76.52 cm)
Finished Exposed Height: 2.63" (6.67 cm)
Depth: 2.5" (6.35 cm)
Architectural Sills per box: 4



































1 1/8" J-Channel (Optional)

Length 12 ft. 6 in. Pieces/Box 30 Linear ft./box 375



TandoStone Architectural Sill and Accessory Complementary Colors

Creek Ledgestone Colors	Architectural Sill and Architectural Sill Corners Complementary Colors	1 1/8" J-Channel Complementary Color	Stacked Stone Colors	Architectural Sill and Architectural Sill Corners Complementary Colors	1 1/8" J-Channel Complementary Color
 Appalachian Ash	  Pewter Raven	 Lewiston Crest	 Chestnut Hills	 Sable	 Chestnut Hills
 Arizona Sandstone	 Sable	 Tan	 Glacier Bay	  Pewter Raven	 Seaside Gray
 Bucks County Gray	 Sable	 Dark Brown	 Lewiston Crest	  Pewter Raven	 Lewiston Crest
 Nordic Mist	 Pewter	 Seaside Gray	 Santa Fe	 Sable	 Santa Fe
 Rocky Mountain Clay	 Sable	 Rocky Mountain Clay	 Sedona Bluff	 Sable	 Sedona Bluff



Beach House Shake[®]
The **Authentic** Composite Shingle



Tando Stone[®]
#1 Brand of Composite Stone



Tando[®] is a registered trademark of
Derby Building Products
© 2023 Derby Building Products

Tando[®]
COMPOSITES



tandocomposites.com | beachhousesshake.com

TS/BHS01 03/2023